

PCB with CNC

- [reference](#)
- fritzing
- online [jscut guide](#)
- online [ncviewer](#)
- online [drill to gcode converter](#)
- TODO online [carbide3d](#)

CNC for PCB:

- 22000RPM
- V-Bit cutter 30 degree 0.2mm
- first pass 0.04mm
- second pass 0.07mm with more feed

fritzing

Make electronic schema with fritzing

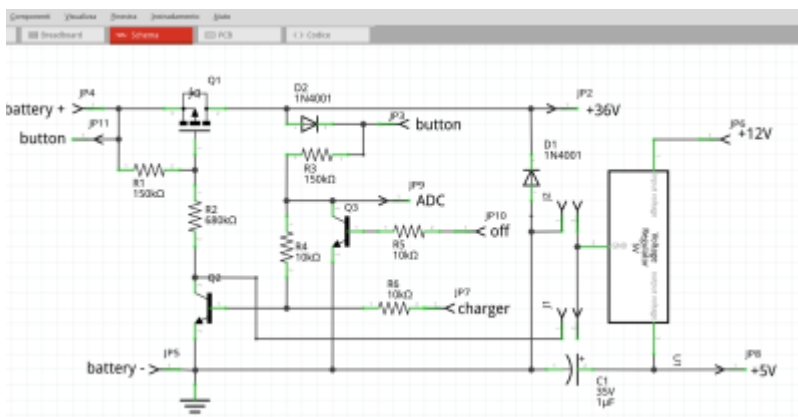

Make pcb routing:

- routing → DRC settings → 32mil large
- routing → DRC (check design at the end)

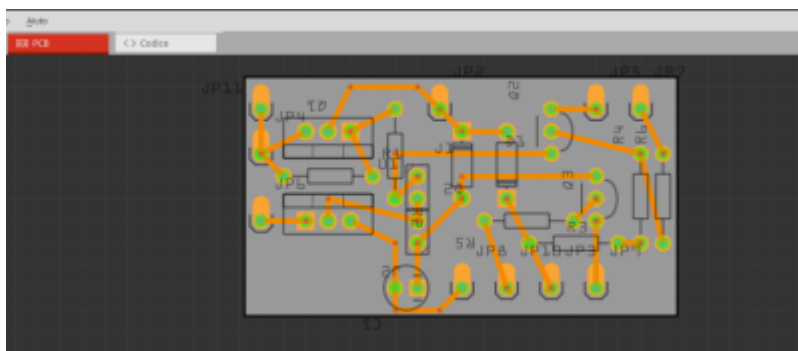

export gerber files

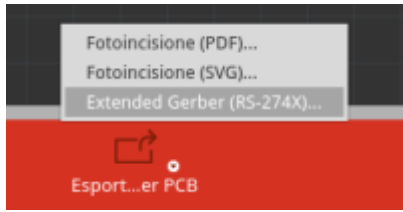

flatcam

setup flatcam

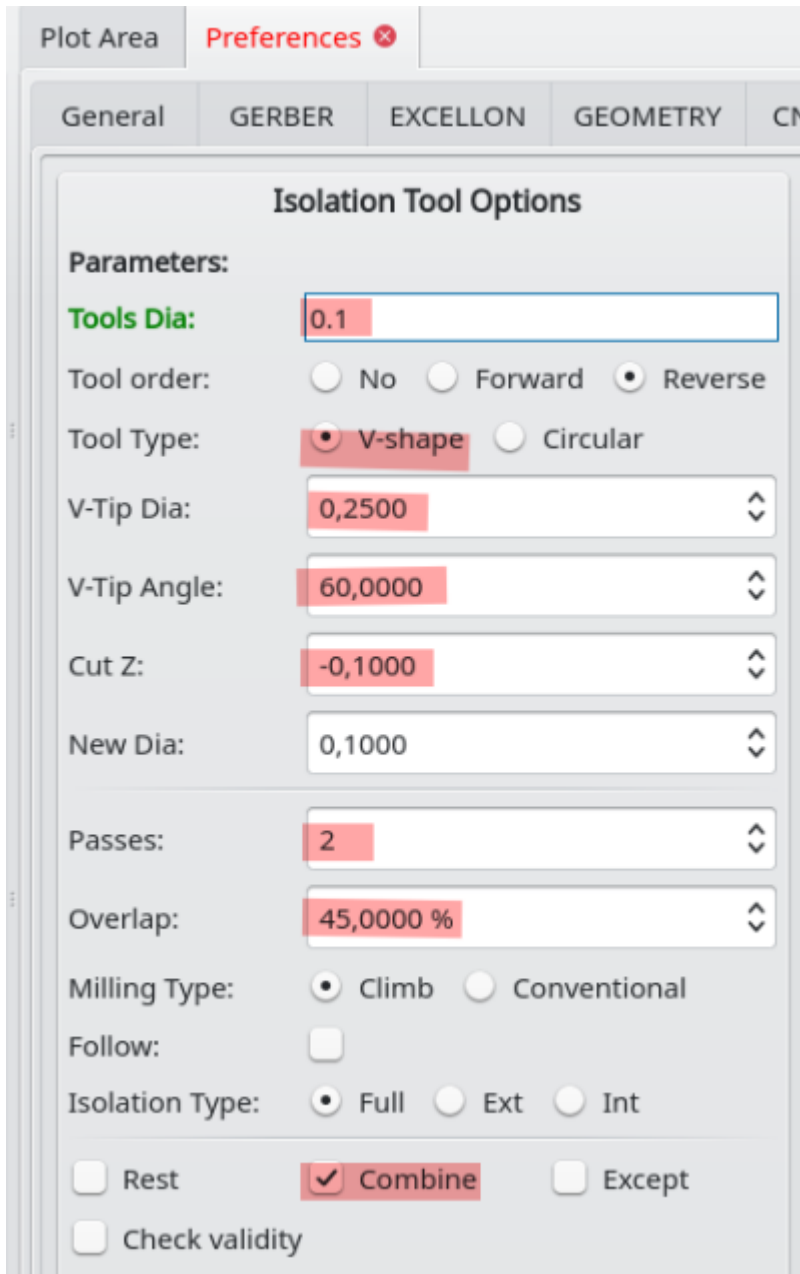

Cutout Tool Options

Parameters:

Tool Diameter: 2,000

Cut Z: -2,000

Multi-Depth: 0,2000

Kind: Single Panel

Margin: 0,1000

Gap size: 4,0000

Plot Area Tools Database

ID	Tool Name
1	v-tool 60 0.1

Tool Description

Name: v-tool 60 0.1

Diameter: 0,1924

Diameter Tolerance: 0,0000

Min: 0,0000

Max: 0,0000

Operations: General

Isolation Parameters

Passes: 2

Overlap: 45,0000 %

Milling Type: Climb Conventional

Follow:

Isolation Type: Full Ext Int

Paint Parameters

Overlap: 20,000 %

Offset: 0,0000

Method: Standard

Connect Contour

NCC Parameters

Operation: Clear Isolation

Milling Type: Climb Conventional

Overcut: 0,0000 %

Drilling Parameters

Cut Z: -2,0000

Offset Z: 0,0000

MultiDepth:

DPP: 0,2000

Travel Z: 2,0000

Feedrate Z: 50,0000

Feedrate Rapids: 500,0000

Spindle speed: 5000

Dwell:

Dwelltime: 0,0000

Drill slots:

Overlap: 0,0000 %

Lost drill:

Milling Parameters

Shape: V

V-Dia: 0,1000

V-Angle: 60,0000

Tool Type: Rough

Tool Offset: Path

Custom Offset: 0,0000

Cut Z: -0,0000

MultiDepth:

DPP: 0,0000

Travel Z: 1,0000

ExtraCut:

E-Cut Length: 0,1000

Feedrate X-Y: 60,0000

Feedrate Z: 60,0000

FR Rapids: 500,0000

Spindle Speed: 6000,0000

Dwell:

Dwelltime: 1,0000

calcolato

open gerber files (top and bottom if present) and exellon drill file

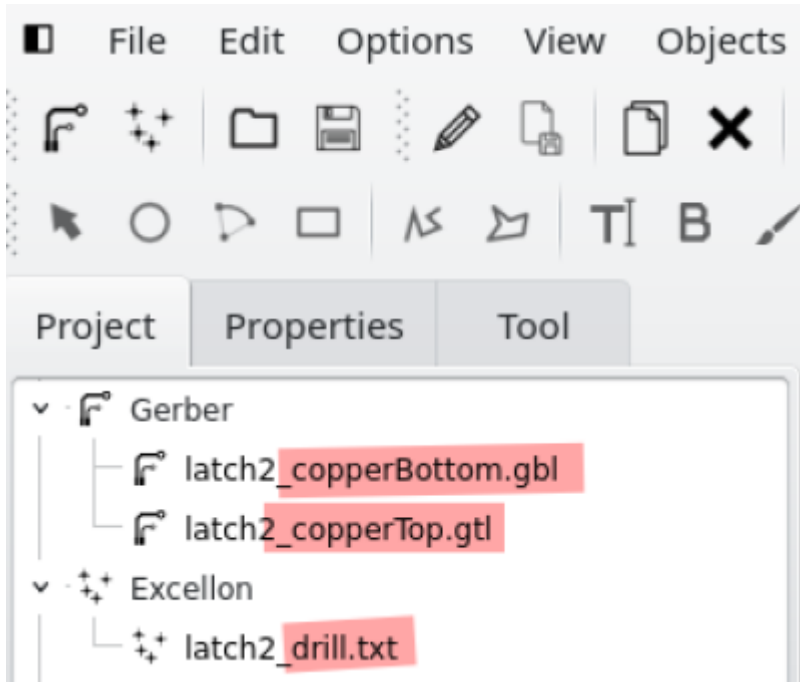

select copper top and

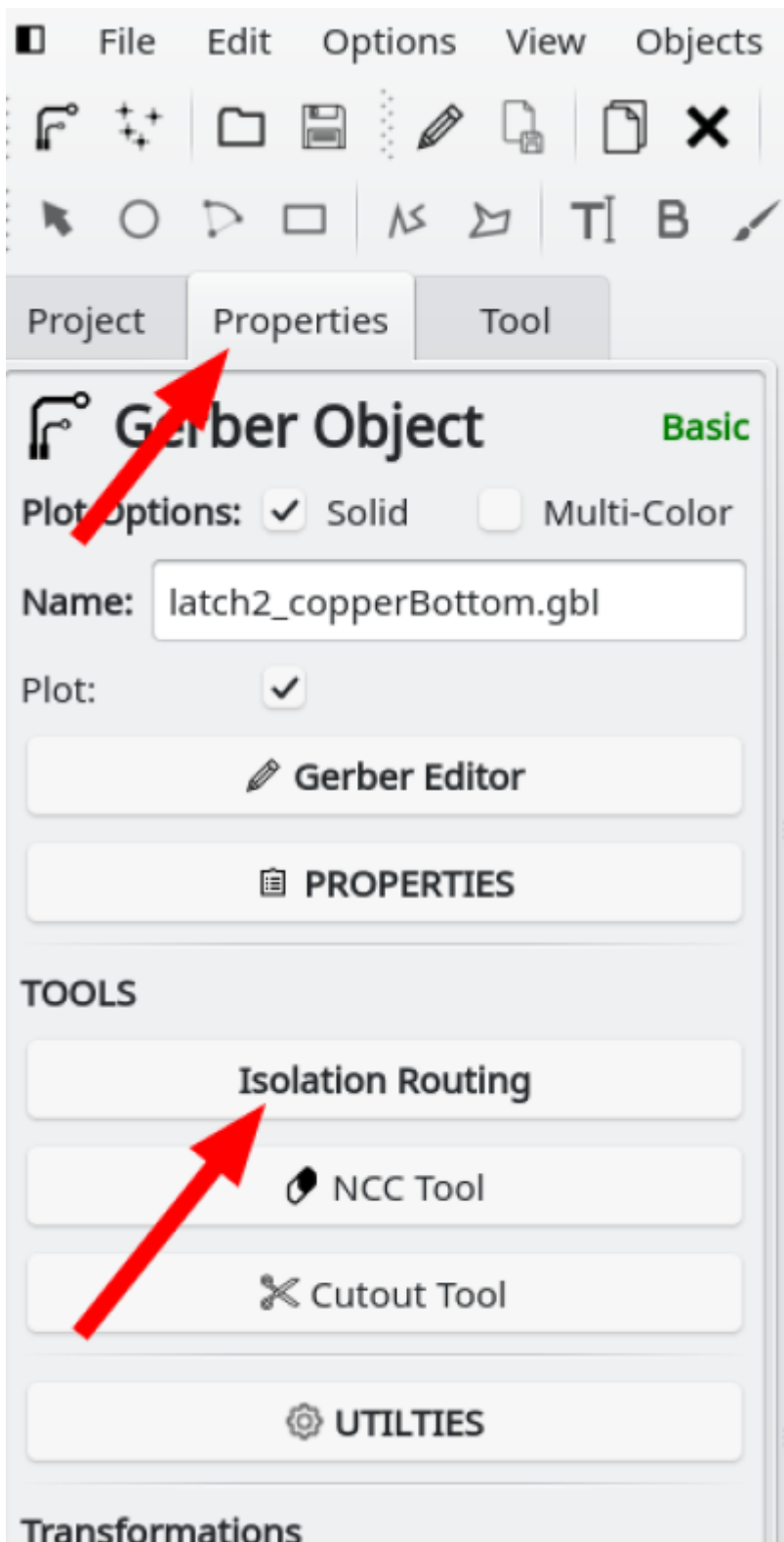

delete tool from tool table 'pick from db' and 'generate geometry'

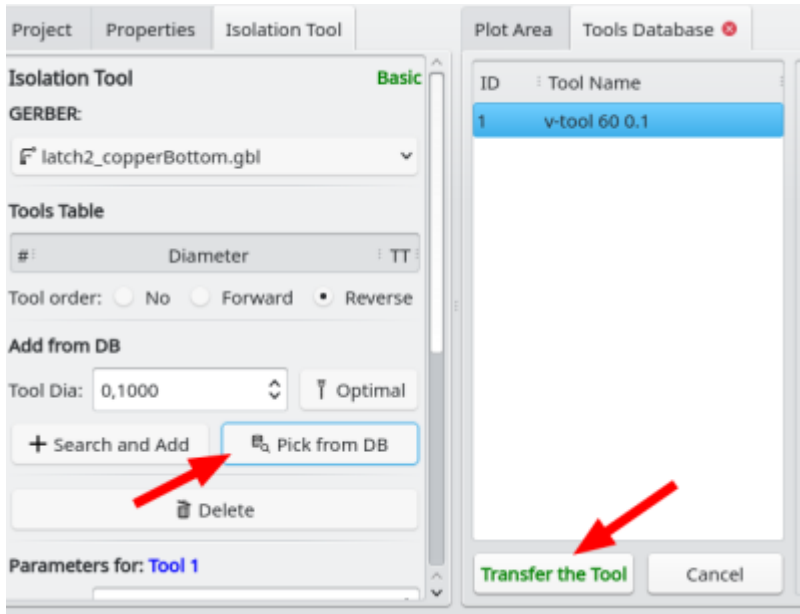

generate cnc job object

Project Properties Isolation Tool

Parameters for: Tool 1

V-Tip Dia: 0,1000

V-Tip Angle: 60,0000

Cut Z: -0,0800

Multi-Depth: 0,8000

Travel Z: 1,0000

Feedrate X-Y: 60,0000

Feedrate Z: 60,0000

Spindle speed: 6000

Dwell: 1,0000

⚙️ Apply parameters to all tools

Common Parameters

Tool change Z: 15,0000

End move Z: 15,0000

End move X,Y: None

Preprocessor: default

Add exclusion areas

Add Polish

🔧 Generate CNCJob object

save gcode file

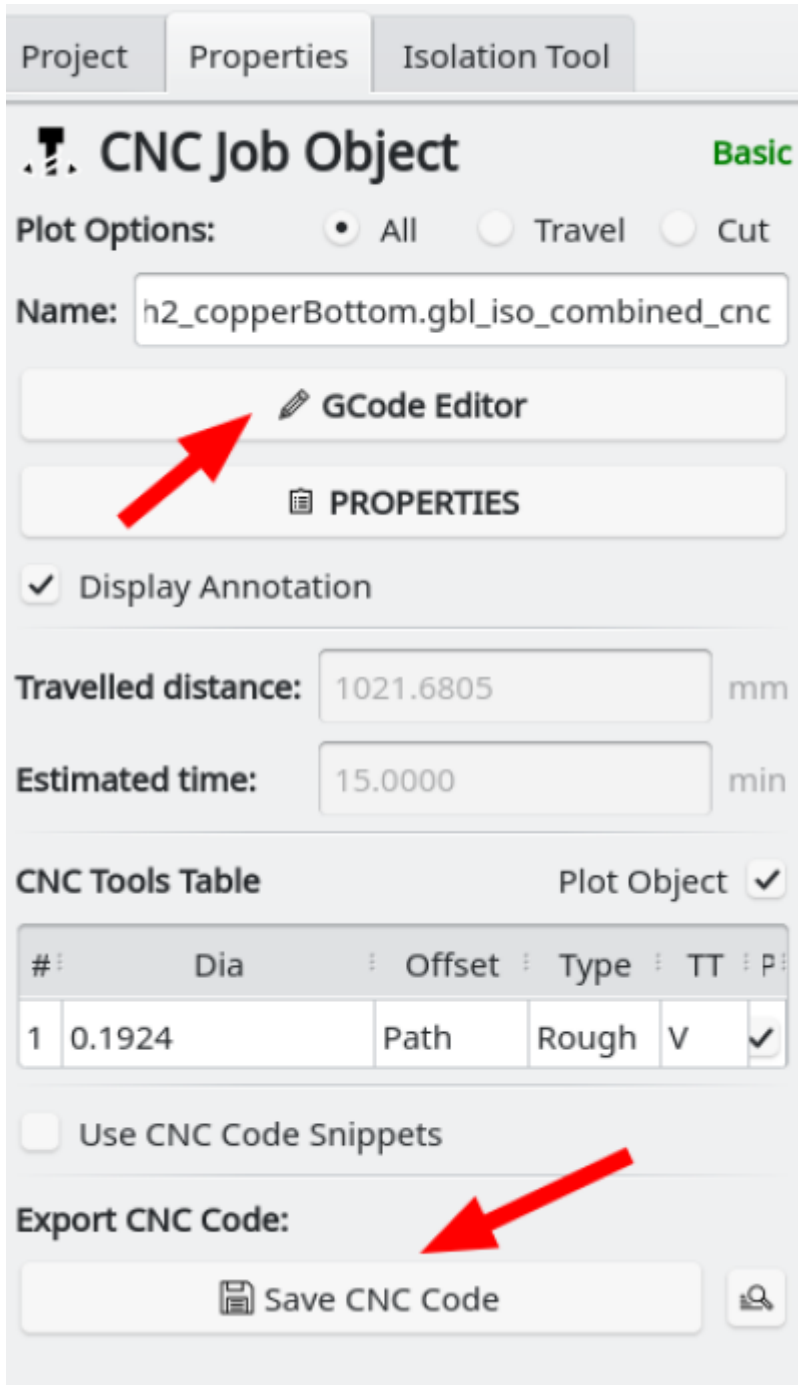

now select *copperBottom.gbl file and make same job to produce gcode for bottom layer. But bottom layer has to be mirrored

deprecated

convert gerber to svg

Upload <name>_copperBottom.gbl to <https://tracespace.io>, select layers, download zip and extract <name>_copperBottom.gbl



Now with inkscape we need to process the complex SVG with multiples path, objects, layers, group, etc. to convert it into a single path simple SVG. You need to open your SVG into Inkscape (Open-Source, cross-platform), and perform the following series of commands:

- CTRL+A (Select all),
- CTRL+U (Ungroup),
- CTRL+ALT+C (Convert stroke to path),
- CTRL+A (Select all),
- CTRL+U (Union) and
- CTRL+SHIFT+R (Fit page to content).
- CTRL+S save

svg to gcode

Open [jscut](#):

- load SVG <name>_copperBottom.gbl
- make all mm (link)
- zero lower left (link)
- select all objets, drills and path
- create operation
 - outside, 0.1mm
- generate
- save gcode

edit gcode to set spindle speed to 8000 rpm and turn on it clockwise (after G90)

```
; after first G1
M3 S5000
```

carbide3d

set spindle speed to 8000 rpm and turn on it clockwise (after G90)

```
G00 Z1.000
M3 S10000
```

substitute G01 F400 with G01 F40

substitute G00 Z3.000 with G00 Z1.000

deprecated

- export your PCB as .svg files by clicking on “Export for PCB” on the bottom. Click on the small arrow on the Export button and select “Etchable (SVG)”. You will get a bunch of svg's exported

in your selected directory but we will only use two of them:

- `yourfilename*_etch_copper_bottom_mirror.svg`
- `yourfilename*_etch_mask_bottom_mirror.svg`

From:

<https://wiki.csgalileo.org/> - **Galileo Labs**

Permanent link:

<https://wiki.csgalileo.org/tips/pcb?rev=1620625800>

Last update: **2021/05/10 07:50**

